



The new degree of comfort.™

## Rheem Classic® Series Air Conditioners



### RA13 Series

Efficiencies up to 15 SEER/13 EER  
Nominal Sizes 1½ to 5 Ton [5.28 to 17.6 kW]  
Cooling Capacities 17.3 to 60.5 kBTU  
[5.7 to 17.7 kW]



*“Proper sizing and installation of equipment is critical to achieve optimal performance. Split system air conditioners and heat pumps must be matched with appropriate coil components to meet Energy Star. Ask your Contractor for details or visit [www.energystar.gov](http://www.energystar.gov).”*

- Composite base pan – dampens sound, captures louver panels, eliminates corrosion and reduces number of fasteners needed
- Powder coat paint system – for a long lasting professional finish
- Scroll compressor – uses 70% fewer moving parts for higher efficiency and increased reliability
- Modern cabinet aesthetics – increased curb appeal with visually appealing design
- Curved louver panels – provide ultimate coil protection, enhance cabinet strength, and increased cabinet rigidity
- Optimized fan orifice – optimizes airflow and reduces unit sound
- Rust resistant screws – confirmed through 1500-hour salt spray testing
- PlusOne™ **Expanded Valve Space** – 3"-4"-5" service valve space – provides a minimum working area of 27-square inches for easier access
- PlusOne™ **Triple Service Access** – 15" wide, industry leading corner service access – makes repairs easier and faster. The two fastener removable corner allows optimal access to internal unit components. Individual louver panels come out once fastener is removed, for faster coil cleaning and easier cabinet reassembly
- Diagnostic service window with two-fastener opening – provides access to the high and low pressure.
- External gauge port access – allows easy connection of “low-loss” gauge ports
- Single-row condenser coil – makes unit lighter and allows thorough coil cleaning to maintain “out of the box” performance
- 35% fewer cabinet fasteners and fastener-free base – allow for faster access to internal components and hassle-free panel removal
- Service trays – hold fasteners or caps during service calls
- QR code – provides technical information on demand for faster service calls
- Fan motor harness with extra long wires allows unit top to be removed without disconnecting fan wire.

## TABLE OF CONTENTS

Standard Feature .....	3
Available SKUs .....	3
Features & Benefits .....	4-5
Model Number Identification .....	6-7
General Data/Electrical Data .....	8
Accessories .....	9
Weighted Sound Power .....	9
Unit Dimensions.....	10
Clearances.....	11
Wiring Diagrams .....	12
Application Guidelines.....	12
Refrigerant Line Size Information .....	13-16
Performance Data .....	17
Guide Specifications .....	18
Limited Warranty .....	19



Air

Standard Feature/Available SKUs  
RA13 Series

## Standard Feature Table

Feature	STANDARD FEATURES						
	18	24	30	36	42	48	60
R-410a Refrigerant	√	√	√	√	√	√	√
Maximum SEER	14.5	14.0	15.0	15.0	14.0	13.5	13.5
Maximum EER	12.5	12.0	13.0	13.0	12.0	11.5	11.5
Scroll Compressor	√	√	√	√	√	√	√
Field Installed Filter Drier	√	√	√	√	√	√	√
Front Seating Service Valves	√	√	√	√	√	√	√
Internal Pressure Relief Valve	√	√	√	√	√	√	√
Internal Thermal Overload	√	√	√	√	√	√	√
Long Line capability	√	√	√	√	√	√	√
Low Ambient capability with Kit	√	√	√	√	√	√	√
3-4-5 Expanded Valve Space	√	√	√	√	√	√	√
Composite Basepan	√	√	√	√	√	√	√
2 Screw Control Box Access	√	√	√	√	√	√	√
15" Access to Internal Components	√	√	√	√	√	√	√
Quick release louver panel design	√	√	√	√	√	√	√
No fasteners to remove along bottom	√	√	√	√	√	√	√
Optimized Venturi Airflow	√	√	√	√	√	√	√
Single row condenser coil	√	√	√	√	√	√	√
Powder coated paint	√	√	√	√	√	√	√
Rust resistant screws	√	√	√	√	√	√	√
QR code	√	√	√	√	√	√	√
External gauge ports	√	√	√	√	√	√	√
Service trays	√	√	√	√	√	√	√

√ = Standard

## Available SKUs

Available Models	Description
RA1318AJ1NA	Classic® Series 1 1/2 ton 13 SEER Single-Stage Air Conditioner-208/230/1/60
RA1318AJ1NB	Classic® Series 1 1/2 ton 13 SEER Single-Stage Air Conditioner-208/230/1/60
RA1324BJ1NA	Classic® Series 2 ton 13 SEER Single-Stage Air Conditioner-208/230/1/60
RA1324BJ1NB	Classic® Series 2 ton 13 SEER Single-Stage Air Conditioner-208/230/1/60
RA1330AJ1NA	Classic® Series 2 1/2 ton 13 SEER Single-Stage Air Conditioner-208/230/1/60
RA1330AJ1NB	Classic® Series 2 1/2 ton 13 SEER Single-Stage Air Conditioner-208/230/1/60
RA1336AC1NB	Classic® Series 3 ton 13 SEER Single-Stage Air Conditioner-208/230/1/60
RA1336AD1NB	Classic® Series 3 ton 13 SEER Single-Stage Air Conditioner-460/3/60
RA1336AJ1NA	Classic® Series 3 ton 13 SEER Single-Stage Air Conditioner-208/230/1/60
RA1336AJ1NB	Classic® Series 3 ton 13 SEER Single-Stage Air Conditioner-208/230/1/60
RA1342AC1NB	Classic® Series 3 1/2 ton 13 SEER Single-Stage Air Conditioner-208/230/1/60
RA1342AD1NB	Classic® Series 3 1/2 ton 13 SEER Single-Stage Air Conditioner-460/3/60
RA1342AJ1NA	Classic® Series 3 1/2 ton 13 SEER Single-Stage Air Conditioner-208/230/1/60
RA1342AJ1NB	Classic® Series 3 1/2 ton 13 SEER Single-Stage Air Conditioner-208/230/1/60
RA1348AC1NB	Classic® Series 4 ton 13 SEER Single-Stage Air Conditioner-208/230/1/60
RA1348AD1NB	Classic® Series 4 ton 13 SEER Single-Stage Air Conditioner-460/3/60
RA1348AJ1NA	Classic® Series 4 ton 13 SEER Single-Stage Air Conditioner-208/230/1/60
RA1348AJ1NB	Classic® Series 4 ton 13 SEER Single-Stage Air Conditioner-208/230/1/60
RA1360AC1NB	Classic® Series 5 ton 13 SEER Single-Stage Air Conditioner-208/230/1/60
RA1360AD1NB	Classic® Series 5 ton 13 SEER Single-Stage Air Conditioner-460/3/60
RA1360AJ1NA	Classic® Series 5 ton 13 SEER Single-Stage Air Conditioner-208/230/1/60
RA1360AJ1NB	Classic® Series 5 ton 13 SEER Single-Stage Air Conditioner-208/230/1/60



## Introduction to RA13 Air Conditioner

The RA13 is our 13 SEER air conditioner and is part of the Rheem air conditioner product line that extends from 13 to 20 SEER. This highly featured and reliable air conditioner is designed for years of reliable, efficient operation when matched with Rheem indoor aluminum evaporator coils and furnaces or air handler units with aluminum evaporators.

Our unique composite base (1) reduces sound emission, eliminates rattles, significantly reduces fasteners, eliminates corrosion and has integrated brass compressor attachment inserts (2). Furthermore it has incorporated into the design, water management features, means for hand placement (3) for unit maneuvering, screw trays (4) and inserts for lifting off unit pad. (5)

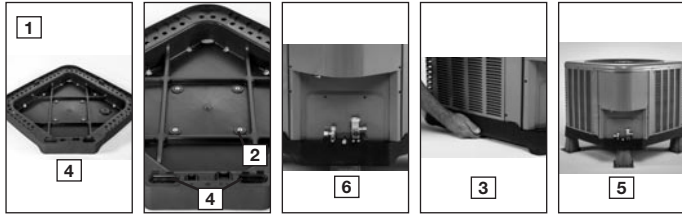

Service Valves (6) are rigidly mounted in the composite base with 3" between suction and discharge valves, 4" clearance below service valves and a minimum of 5" above the service valves, creating industry leading installation ease. The minimum 27 square-inches around the service valves allows ample room to remove service valve schrader prior to brazing, plenty of clearance for easy brazing of the suction and discharge lines to service valve outlets, easy access and hookup of low loss refrigerant gauges (7), and access to the service valve caps for opening. For applications with long-line lengths up to 250 feet total equivalent length, up to 200 feet condenser above evaporator, or up to 80 feet evaporator above condenser, the long-line instructions in the installation manual should be followed.

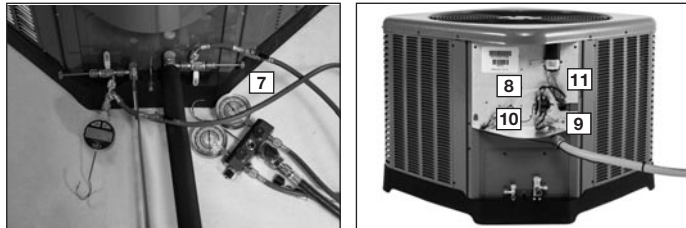

Controls are accessed from the corner of the unit by removing only two fasteners from the control access cover, revealing the industry's largest 15" wide and 14" tall control area (8). With all this room in the control area the high voltage electrical whip (9) can easily be inserted through the right size opening in the bottom of the control area. Routing it leads directly to contractor lugs for connection. The low voltage control wires (10) are easily connected to units low voltage wiring. If contactor or capacitor (11) needs to be replaced there is more than adequate space to make the repair. Furthermore, if high pressure and low pressure model was not purchased but is desired to be installed in the field, the service window (12) can be removed by removing two screws, to access the high and low side schrader fittings for easy field installation. The entire corner can be removed providing ultimate access to install the high and low pressure switch. (13)

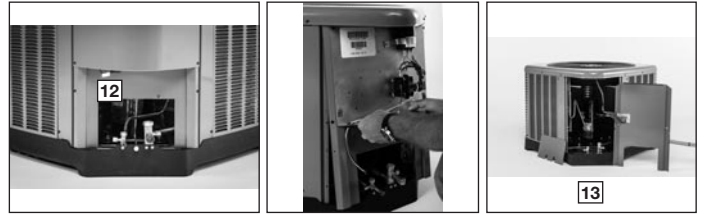

If in the rare event, greater access is needed to internal components, such as the compressor, the entire corner of the unit can be removed along with the top cover assembly to have unprecedented access to interior of the unit (14). Extra wire length is incorporated into each outdoor fan and compressor so top cover and control panel can be positioned next to the unit. With minimal effort the plug can be removed from the compressor and the outdoor fan wires can be removed from the capacitor to allow even more uncluttered access to the interior of the unit (15). Outdoor coil heights range from as short as 22" to 28", aiding access to the compressor. Disassembly to this degree and complete reassembly only takes a first time service technician less than 10 minutes. (15)

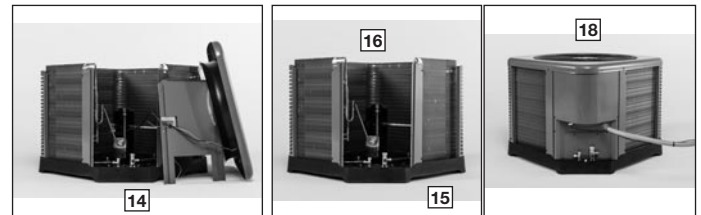

All units utilize strong formed louver panels which provide industry leading coil protection. Louver removal for coil cleaning is accomplished by removing one screw and lifting the panel out of the composite base pan. (17) All RA13 units utilize single row coils (16) making cleaning easy and complete, restoring the performance of the air conditioner back to out of the box performance levels year after year.



The outdoor fan motor has sleeve bearings and is inherently protected. The motor is totally enclosed for maximum protection from weather, dust and corrosion. Access to the outdoor fan is made by removing four fasteners from the fan grille. The outdoor fan can be removed from the fan grille by removing 4 fasteners in the rare case outdoor fan motor fails.

Each cabinet has optimized composite (19) fan orifice assuring efficient and quiet airflow.



The entire cabinet has powder post paint (20) achieving 1000 hour salt spray rating, allowing the cabinet to retain its aesthetics throughout its life.



Scroll compressors with standard internal pressure relief and internal thermal overload are used on all capacities assuring longevity of high efficient and quiet operation for the life of the product.

Each unit is shipped with filter drier for field installation and will trap any moisture or dirt that could contaminate the refrigerant system.

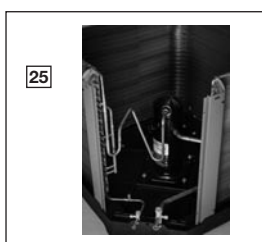

All cabinets have industry leading structural strength due to the composite base pan (21), interlocking corner post (22), formed curved louver panels (23) and drawn top cover (24) making it the most durable cabinet on the market today.

Each RA13 capacity has undergone rigorous psychrometric testing to assure performance ratings of capacity, SEER and EER per AHRI Standard 210/240 rating conditions. Also each unit bears the UL mark and each unit is certified  to UL 1995 safety standards.

Each unit has undergone specific strain and modal testing to assure tubing (25) is outside the units natural frequency and that the suction and discharge lines connected to the compressor withstand any starting, steady state operation or shut down forces imposed by the compressor.

All units have been sound tested in sound chamber to AHRI 270 rating conditions, and A-weighted Sound Power Level tables produced, assuring units have acceptable noise qualities (see page 9). Each unit has been ran in cooling operation at 95°F and 82°F and sound ratings for the RA13 range from as low as 73 dBA to 79 dBA.

All units have been ship tested to assure units meet stringent “over the road” shipping conditions.

As manufactured all units in the RA13 family have cooling capability to 55 °F. Addition of low ambient control will allow the unit to operate down to 0°F. Factory testing is performed on each unit. All component parts meet well defined specification and continually go through receiving inspections. Each component installed on a unit is scanned, assuring correct component utilization for a given unit capacity and voltage. All condenser coils are leak tested with pressurization test to 550#’s and once installed and assembled, each units’ complete refrigerant system is helium leak tested. All units are fully charged from the factory for up to 15 feet of piping. All units are factory run tested. The RA13 has a 10-year conditional compressor and parts warranty (registration required).

## Optional Accessories (Refer to accessory chart for model #)

### Compressor Crankcase Heater

Protects against refrigerant migration that can occur during low ambient operation

### Compressor Sound Cover

- Reinforced vinyl compressor cover containing a 1½ inch thick batt of fiberglass insulation
- Open edges are sealed with a one-inch wide hook and loop fastening tape

### Compressor Hard Start Kit

- Single-phase units are equipped with a PSC compressor motor, this type of motor normally does not need a potential relay and start capacitor
- Kit may be required to increase the compressor starting torque, in conditions such as low voltage

### Low Ambient Kit

- Air conditioners operate satisfactorily in the cooling mode down to 55°F outdoor air temperature without any additional controls
- This Kit can be added in the field enabling unit to operate properly down to 0° in the cooling mode
- Crankcase heater and freezestat should be installed on compressors equipped with a low ambient kit

### 3"/6"/12"

- Gray high density polyethylene feet are available to raise unit off of mounting surface away from moisture

### Low Pressure

- Can be added in field enabling the unit to shut off compressor on loss of charge

NOTE: Unit can be purchased with high and low pressure installed at factory. (Refer to SKU list)

### High Pressure

- Can be added in field enabling unit to shut off compressor if unit loses outdoor fan operation.

NOTE: Unit can be purchased with high and low pressure installed at factory. (Refer to SKU list)

### Decorative Top

- Can be installed on fan grille



# Air Conditioners\*

R	A	13	24	A	J	1	N	A	*
Brand	Product Category	SEER	Capacity BTU/HR	Major Series*	Voltage	Type	Controls	Minor Series**	Option Code
Rheem	A - Air Conditioners	13 - 13 SEER	18 - 18,000 [5.28 kW] 24 - 24,000 [7.03 kW] 30 - 30,000 [8.79 kW] 36 - 36,000 [10.55 kW] 42 - 42,000 [12.31 kW] 48 - 48,000 [14.07 kW] 60 - 60,000 [17.58 kW]	A - 1st Design B - 2nd Design	J - 1ph, 208-230/60 C - 3ph, 208-230/60 D - 3ph, 460/60	1 - Single-stage	N - Non-Communicating	A - 1st Design B - 2nd Design	N/A

\*See page 3 for available SKU's.

# Heat Pumps (For Reference)\*\*

R	P	14	24	A	J	1	N	A	*
Brand	Product Category	SEER	Capacity BTU/HR	Major Series*	Voltage	Type	Controls	Minor Series**	Option Code
Rheem	P - Heat Pump	13 - 13 SEER 14 - 14 SEER 15 - 15 SEER 17 - 17 SEER 20 - 20 SEER	18 - 18,000 [5.28 kW] 24 - 24,000 [7.03 kW] 30 - 30,000 [8.79 kW] 36 - 36,000 [10.55 kW] 42 - 42,000 [12.31 kW] 48 - 48,000 [14.07 kW] 60 - 60,000 [17.58 kW]	A - 1st Design	J - 1ph, 208-230/60 C - 3ph, 208-230/60 D - 3ph, 460/60	1 - Single-stage 2 - Two-stage V - Inverter P - Piston	C - Communicating N - Non-Communicating	A - 1st Design	N/A

# Furnace Coils (For Reference)\*\*

R	C	F	17	24	S	T	A	M	C	A	*
Brand	Product Category	Type	Width	Capacity BTU/HR	Efficiency	Metering Device	Major Series*	Orientation	Casing	Minor Series**	Option Code
Rheem	C - Evap Coil	F - Furn Coil H - Air-Handler Coil	14 - 14" 17 - 17.5" 21 - 21" 24 - 24.5"	24 - 24,000 [7.03 kW] 36 - 36,000 [10.55 kW] 48 - 48,000 [14.07 kW] 60 - 60,000 [17.58 kW]	S - Standard Eff. M - Mid Eff. H - High Eff.	T-TXV E-EEV P-Piston	A - 1st Design	M - Multipoise V - Vertical only/ convertible H - Ded. Horizontal only	C - Cased U - Uncased	A - 1st Design	N/A

\*\*Model number ID's are for reference only. See available SKU page of applicable spec sheet for table of available SKU's for a specific model.

[ ] Designates Metric Conversions





## 90%+ AFUE Gas Furnaces (For Reference)\*\*

R	96	V	A	70	2	3	17	M	S	A
Brand	Series	Motor	Major Rev	Input BTU/HR	Stages	Air Flow	Cabinet Width	Configuration	Nox	Minor Rev
Rheem	90 - 90 AFUE	V - Variable speed	A - 1st Design	040 - 42,000 [12.31 kW]	1 - Single-stage	3 - up to 3 ton	14 - 14"	M - Multi	X - Low Nox	A - 1st Design
	92 - 92 AFUE	T - Constant Torque		060 - 56,000 [16.41 kW]	2 - Two-stage	5 - 3 1/2 up to 5 ton	17 - 17.5"		S - Standard	
	95 - 95 AFUE	(X-13)		070 - 70,000 [20.51 kW]	M - Modulating		21 - 21"			
	96 - 96 AFUE	P - PSC		085 - 84,000 [24.62 kW]			24 - 24.5"			
	97 - 97 AFUE			100 - 98,000 [28.72 kW]						
				115 - 112,000 [32.82 kW]						

## 80% AFUE Gas Furnaces (For Reference)\*\*

R	80	2	V	A	075	3	17	M	S	A
Brand	Series	Stages	Motor	Major Rev	Input BTU/HR	Air Flow	Cabinet Width	Configuration	Nox	Minor Rev
Rheem	80 - 80+ AFUE	1 - Single-stage	V - Variable speed	A - 1st Design	050 - 50,000 [15 kW]	3 - up to 3 ton	14 - 14"	M - Multi	X - Low Nox	A - 1st Design
		2 - Two-stage	T - Constant Torque (X-13)		075 - 75,000 [22 kW]	4 - 2 1/2 to 4 ton	17 - 17.5"	D - Down	S - Standard	
			P - PSC premium		100 - 100,000 [29 kW]	5 - 3 1/2 up to 5 ton	21 - 21"	Z - Down & zero clearance		
			S - PSC standard		125 - 125,000 [37 kW]		24 - 24.5"	down flow		
					150 - 150,000 [44 kW]					

## Air Handlers (For Reference)\*\*

R	H	1	I	36	17	S	I	A	N	A	*	
Brand	Product Category	Stages of Airflow	Motor Type	Capacity BTU/HR	Width	Coil Size	Metering Device	Major Series*	Controls	Voltage	Minor Series**	Factory Heat Cap Code
Rheem	H - Air Handler	1 - Single-Stage	V - Variable Speed	24 - 24,000 [7.03 kW]	14 - 14"	S - Standard Eff.	T - TEV	A - 1st Design	C - Communicating	A - 1ph, 115/60	A - 1st Design	00 - no factory heat with option code
		2 - Two-Stage	T - Constant Torque	36 - 36,000 [10.55 kW]	17 - 17.5"	M - Mid Eff.	E - EEV	N - Non-comm	N - Non-comm	J - 1ph, 208-240/60		
		M - Modulating	P - PSC	48 - 48,000 [14.07 kW]	21 - 21"	H - High Eff.	P - Piston		D - 3ph, 480/60	D - 3ph, 480/60		
				60 - 60,000 [17.58 kW]	24 - 24.5"							

\*\*Model number ID's are for reference only. See available SKU page of applicable spec sheet for table of available SKU's for a specific model.

[ ] Designates Metric Conversions



## Physical Data

PHYSICAL DATA							
Model No.	RA1318	RA1324	RA1330	RA1336	RA1342	RA1348	RA1360
Nominal Tonnage	1.5	2.0	2.5	3.0	3.5	4.0	5.0
<b>Valve Connections</b>							
Liquid Line O.D. – in.	3/8	3/8	3/8	3/8	3/8	3/8	3/8
Suction Line O.D. – in.	3/4	3/4	3/4	3/4	7/8	7/8	7/8
Refrigerant (R410A) furnished oz. <sup>1</sup>	54	60	72	86	105	106	148
Compressor Type	Scroll						
<b>Outdoor Coil</b>							
Net face area – Outer Coil	5.9	9.1	9.1	12.1	14.2	14.8	18.8
Net face area – Inner Coil	—	—	—	—	—	—	—
Tube diameter – in.	3/8	3/8	3/8	3/8	3/8	3/8	3/8
Number of rows	1	1	1	1	1	1	1
Fins per inch	22	18	22	22	22	22	22
<b>Outdoor Fan</b>							
Diameter – in.	20	20	20	20	20	24	26
Number of blades	2	2	3	3	2	3	2
Motor hp	1/8	1/8	1/4	1/4	1/8	1/6	1/5
CFM	2040	2325	2795	2900	2465	4145	3870
RPM	1075	1075	1075	1075	1075	850	820
watts	144	137	189	186	176	279	235
Shipping weight – lbs.	127	142	163	164	195	202	235
Operating weight – lbs.	120	135	156	157	188	195	228

## Electrical Data

Line Voltage Data (Volts-Phase-Hz)	208/230-1-60	208/230-1-60	208/230-1-60	208/230-1-60	208/230-1-60	208/230-1-60	208/230-1-60
Maximum overcurrent protection (amps) <sup>2</sup>	20	25	30	35	40	50	60
Minimum circuit ampacity <sup>3</sup>	13	15	18	23	24	29	35
<b>Compressor</b>							
Rated load amps	9.7	11.2	12.8	16.7	17.9	21.8	26.4
Locked rotor amps	48	60.8	64	83.9	112	117	134
<b>Condenser Fan Motor</b>							
Full load amps	0.7	0.7	1.3	1.3	0.7	1	1.2
Locked rotor amps	1.3	1.3	2.5	2.6	1.3	2.2	2.0
Line Voltage Data (Volts-Phase-Hz)	—	—	—	208/230-3-60	208/230-3-60	208/230-3-60	208/230-3-60
Maximum overcurrent protection (amps) <sup>2</sup>	—	—	—	20	30	30	35
Minimum circuit ampacity <sup>3</sup>	—	—	—	15	18	19	22
<b>Compressor</b>							
Rated load amps	—	—	—	10.4	13.2	13.7	16
Locked rotor amps	—	—	—	73	88	83.1	110
<b>Condenser Fan Motor</b>							
Full load amps	—	—	—	1.3	0.7	1	1.3
Locked rotor amps	—	—	—	2.6	1.3	2.2	2.0
Line Voltage Data (Volts-Phase-Hz)	—	—	—	480-3-60	480-3-60	480-3-60	480-3-60
Maximum overcurrent protection (amps) <sup>2</sup>	—	—	—	15	15	15	15
Minimum circuit ampacity <sup>3</sup>	—	—	—	8	8	9	11
<b>Compressor</b>							
Rated load amps	—	—	—	5.8	6.0	6.2	7.8
Locked rotor amps	—	—	—	38	44	41	52
<b>Condenser Fan Motor</b>							
Full load amps	—	—	—	.6	.3	.6	.6
Locked rotor amps	—	—	—	2.5	.9	1.6	1.1

<sup>1</sup>Refrigerant charge sufficient for 15 ft. length of refrigerant lines. For longer line set requirements see the installation instructions for information about set length and additional refrigerant charge required.

<sup>2</sup>HACR type circuit breaker or fuse.

<sup>3</sup>Refer to National Electrical Code manual to determine wire, fuse and disconnect size requirements.





## Accessories

Model No.	RA1318	RA1324	RA1330	RA1336	RA1342	RA1348	RA1360	
Compressor crankcase heater*	44-17402-44	44-17402-44	44-17402-44	44-17402-44	44-17402-45	44-17402-45	44-17402-45	
Low ambient control	RXAD-A08	RXAD-A08	RXAD-A08	RXAD-A08	RXAD-A08	RXAD-A08	RXAD-A08	
Compressor sound cover	68-23427-26	68-23427-26	68-23427-26	68-23427-26	68-23427-25	68-23427-25	68-23427-25	
Compressor hard start kit	SK-A1	SK-A1	SK-A1	SK-A1	SK-A1	SK-A1	SK-A1	
Compressor time delay	RXMD-B01	RXMD-B01	RXMD-B01	RXMD-B01	RXMD-B01	RXMD-B01	RXMD-B01	
Low pressure control	RXAC-A07	RXAC-A07	RXAC-A07	RXAC-A07	RXAC-A07	RXAC-A07	RXAC-A07	
High pressure control	RXAB-A07	RXAB-A07	RXAB-A07	RXAB-A07	RXAB-A07	RXAB-A07	RXAB-A07	
Liquid Line Solenoid (24 VAC, 50/60 Hz)	Solenoid Valve	200RD2T3TVLC	200RD2T3TVLC	200RD2T3TVLC	200RD2T3TVLC	200RD2T3TVLC	200RD3T3TVLC	200RD3T3TVLC
	Solenoid Coil	61-AMG24V	61-AMG24V	61-AMG24V	61-AMG24V	61-AMG24V	61-AMG24V	61-AMG24V
Liquid Line Solenoid (120/240 VAC, 50/60 Hz)	Solenoid Valve	200RD2T3TVLC	200RD2T3TVLC	200RD2T3TVLC	200RD2T3TVLC	200RD2T3TVLC	200RD3T3TVLC	200RD3T3TVLC
	Solenoid Coil	61-AMG120/240V	61-AMG120/240V	61-AMG120/240V	61-AMG120/240V	61-AMG120/240V	61-AMG120/240V	61-AMG120/240V
Top Cap w/Label	91-101123-21	91-101123-21	91-101123-21	91-101123-21	91-101123-21	91-101123-21	91-101123-21	

\*Crankcase Heater recommended with Low Ambient Kit.

## Weighted Sound Power Level (dBA)

RA13 Sound Power Level								
Model	Sound Power Level [dB(A)]	Full Octave Linear Sound Power Level dB - Center Frequency - Hz						
		125	250	500	1000	2000	4000	8000
RA1318	72.0	51.7	58.3	61.5	61.1	57.0	54.0	47.0
RA1324	75.0	55.4	60.3	64.7	66.4	62.6	58.0	52.4
RA1330	78.0	51.4	67.1	67.5	68.2	65.5	59.8	53.6
RA1336	77.0	55.1	66.1	66.9	68.2	64.6	60.7	55.6
RA1342	73.0	48.9	56.1	62.9	62.2	61.1	55.2	50.2
RA1348	76.0	51.4	59.6	65.2	65.9	64.3	58.5	53.7
RA1360	78.0	51.7	60.9	66.9	70.4	63.5	57.4	53.8

NOTE: Tested in accordance with AHRI Standard 270-08 (not listed in AHRI)

## Unit Dimensions

MODEL NO.	OPERATING						SHIPPING					
	H (Height)		L (Length)		W (Width)		H (Height)		L (Length)		W (Width)	
	INCHES	mm	INCHES	mm	INCHES	mm	INCHES	mm	INCHES	mm	INCHES	mm
RA1318	27	685	29.75	755	29.75	755	28.75	730	32.38	822	32.38	822
RA1324	25	635	29.75	755	29.75	755	26.75	679	32.38	822	32.38	822
RA1330	25	635	29.75	755	29.75	755	26.75	679	32.38	822	32.38	822
RA1336	27	685	29.75	755	29.75	755	28.75	730	32.38	822	32.38	822
RA1342	31	787	29.75	755	29.75	755	32.75	831	32.38	822	32.38	822
RA1348	27	685	33.75	857	33.75	857	28.75	730	36.38	924	36.38	924
RA1360	31	787	35.75	908	35.75	908	32.75	831	38.38	974	38.38	974

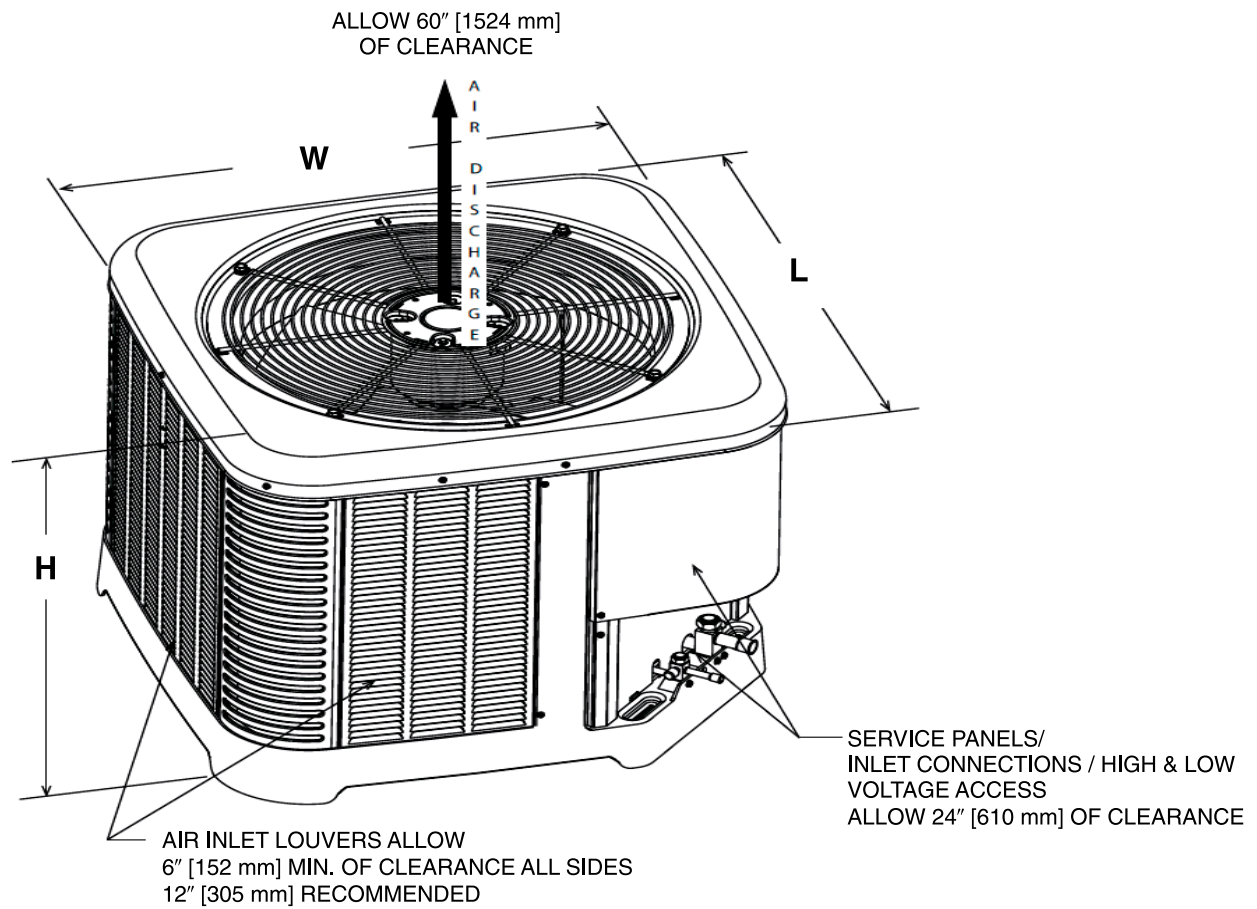

[ ] Designates Metric Conversions

ST-A1226-02-00

# CLEARANCES

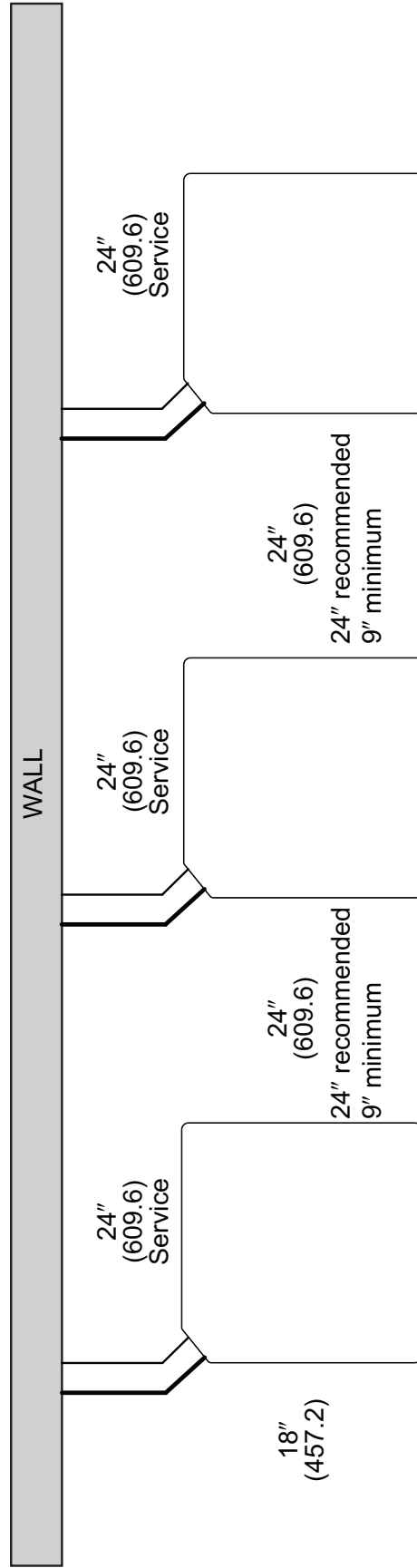
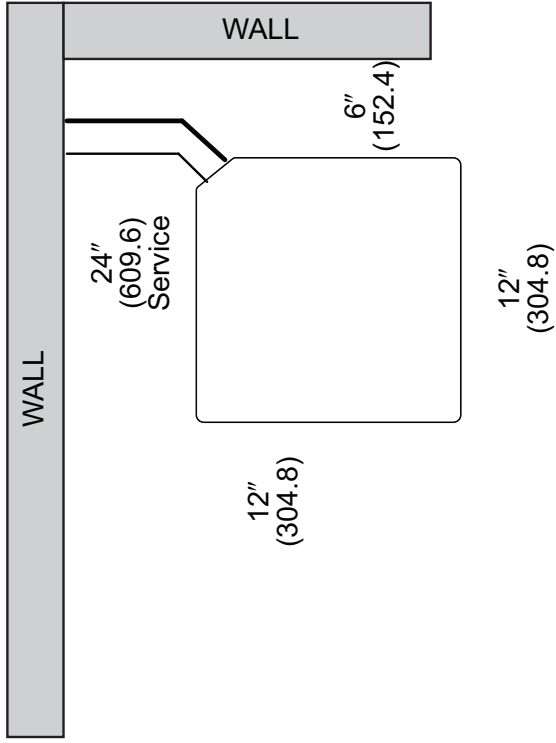
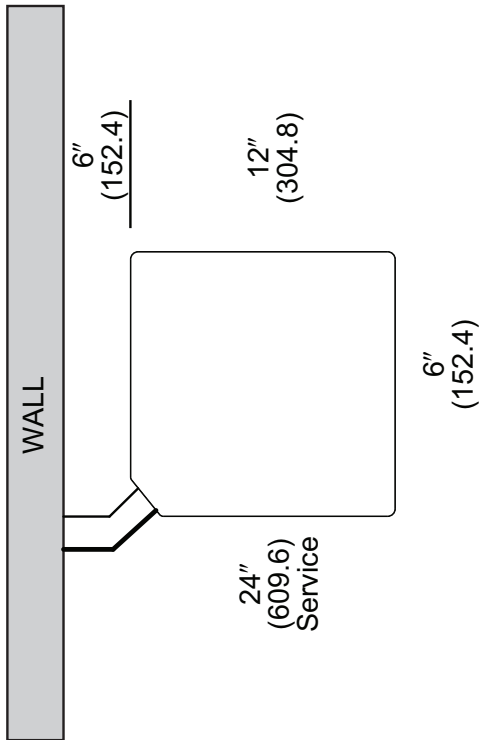

**NOTE: NUMBERS IN ( ) = mm**

IMPORTANT: When installing multiple units in an alcove, roof well or partially enclosed area, ensure there is adequate ventilation to prevent re-circulation of discharge air.

## Control Wiring

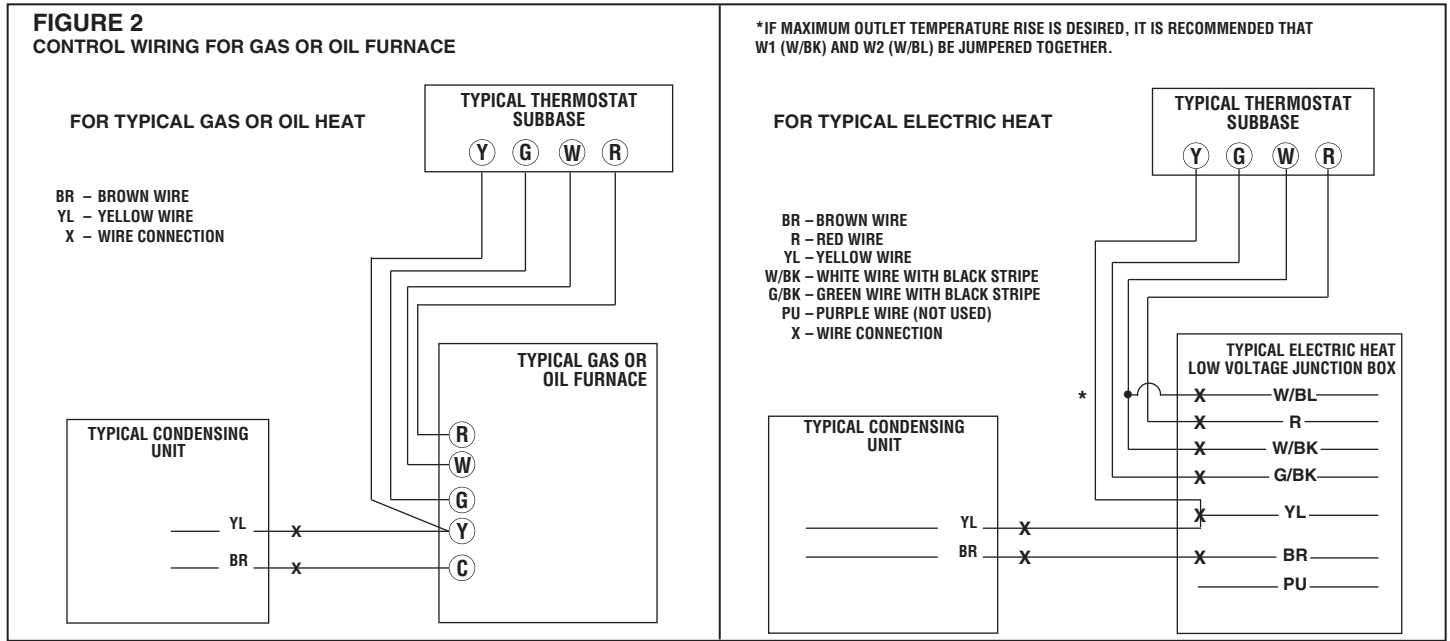

## Application Guidelines

1. Intended for outdoor installation with free air inlet and outlet. Outdoor fan external static pressure available is less than 0.01 -in. wc.
2. Minimum outdoor operation air temperature for cooling mode without low-ambient operation accessory is 55°F (12.8°C).
3. Maximum outdoor operating air temperature is 125°F (51.7°C).
4. For reliable operation, unit should be level in all horizontal planes.
5. Use only copper wire for electric connections at unit. Aluminum and clad aluminum are not acceptable for the type of connector provided.
6. Do not apply capillary tube indoor coils to these units.
7. Factory – supplied filter drier must be installed.



Air

## Refrigerant Line Size Information

13 - 16 SEER Single-Stage Air-Conditioners															
Unit Size	Allowable Liquid Line Size	Allowable Suction Line Size	Apply Long Line Guidelines if Linear Line Length Exceeds Those Shown Below (Feet)	Equivalent Length (Feet)											
				< 25	26-50	51-75	76-100	101-125	126-150	151-175	176-200	201-225	226-250		
				Maximum Vertical Rise (Outdoor Unit Below Indoor Unit) * / Capacity Multiplier											
1.5 Ton **SEE NOTE 3	1/4"	5/8"	N/A	25 / 1.00	50 / 0.99	62 / 0.98	43 / 0.98	24 / 0.97	5 / 0.97	NR	NR	NR	NR	NR	NR
	5/16"	5/8"	N/A	25 / 1.00	50 / 0.99	75 / 0.98	98 / 0.98	93 / 0.97	88 / 0.97	83 / 0.96	78 / 0.96	73 / 0.95	68 / 0.94	100 / 0.94	100 / 0.94
	3/8"	5/8"	178	25 / 1.00	50 / 0.99	75 / 0.98	100 / 0.98	100 / 0.97	100 / 0.97	100 / 0.97	100 / 0.96	100 / 0.95	100 / 0.94	NR	NR
	1/4"	3/4**	N/A	25 / 1.00	50 / 1.00	62 / 0.99	43 / 0.99	24 / 0.99	5 / 0.99	NR	NR	NR	NR	NR	NR
	5/16"	3/4**	N/A	25 / 1.00	50 / 1.00	75 / 0.99	98 / 0.99	93 / 0.99	88 / 0.99	83 / 0.99	78 / 0.98	73 / 0.98	68 / 0.98	100 / 0.98	100 / 0.98
	3/8"	3/4**	178	25 / 1.00	50 / 1.00	75 / 1.00	100 / 0.99	100 / 0.99	100 / 0.99	100 / 0.99	100 / 0.99	100 / 0.98	100 / 0.98	100 / 0.98	100 / 0.98
2 Ton	1/4"	5/8"	N/A	25 / 0.99	50 / 0.98	21 / 0.97	NR	NR	NR	NR	NR	NR	NR	NR	NR
	5/16"	5/8"	213	25 / 0.99	50 / 0.98	75 / 0.97	87 / 0.96	77 / 0.95	69 / 0.94	61 / 0.93	53 / 0.92	45 / 0.91	37 / 0.90	89 / 0.90	89 / 0.90
	3/8"	5/8"	142	25 / 0.99	50 / 0.98	75 / 0.97	100 / 0.96	100 / 0.95	100 / 0.94	98 / 0.93	95 / 0.92	92 / 0.91	89 / 0.90	NR	NR
	1/4"	3/4"	N/A	25 / 1.00	50 / 1.00	21 / 0.99	NR	NR	NR	NR	NR	NR	NR	NR	NR
	5/16"	3/4"	213	25 / 1.00	50 / 1.00	75 / 0.99	87 / 0.99	77 / 0.98	69 / 0.98	61 / 0.98	53 / 0.97	45 / 0.97	37 / 0.96	90 / 0.96	90 / 0.96
	3/8"	3/4"	142	25 / 1.00	50 / 1.00	75 / 0.99	100 / 0.99	100 / 0.98	100 / 0.98	100 / 0.98	98 / 0.98	95 / 0.97	93 / 0.97	90 / 0.96	90 / 0.96
2.5 Ton	5/16"	5/8"	N/A	25 / 0.99	50 / 0.98	75 / 0.96	70 / 0.94	59 / 0.93	48 / 0.91	36 / 0.90	NR	NR	NR	NR	NR
	3/8"	5/8"	142	25 / 0.99	50 / 0.98	75 / 0.96	100 / 0.94	98 / 0.93	94 / 0.91	90 / 0.90	NR	NR	NR	NR	NR
	5/16"	3/4"	213	25 / 1.00	50 / 0.99	75 / 0.99	70 / 0.98	59 / 0.98	48 / 0.97	36 / 0.96	25 / 0.96	13 / 0.95	NR	NR	NR
	3/8"	3/4"	142	25 / 1.00	50 / 0.99	75 / 0.99	100 / 0.98	98 / 0.98	94 / 0.97	90 / 0.96	86 / 0.96	82 / 0.95	78 / 0.95	NR	NR
	5/16"	5/8"	N/A	25 / 0.99	50 / 0.97	66 / 0.94	49 / 0.92	32 / 0.90	NR	NR	NR	NR	NR	NR	NR
	3/8"	5/8"	108	25 / 0.99	50 / 0.97	75 / 0.94	95 / 0.92	89 / 0.90	NR	NR	NR	NR	NR	NR	NR
3 Ton	5/16"	3/4"	N/A	25 / 1.00	50 / 0.99	66 / 0.98	49 / 0.98	32 / 0.97	15 / 0.96	NR	NR	NR	NR	NR	NR
	3/8"	3/4"	108	25 / 1.00	50 / 0.99	75 / 0.98	95 / 0.98	89 / 0.97	84 / 0.96	78 / 0.95	72 / 0.94	67 / 0.93	61 / 0.93	100 / 0.93	100 / 0.93
	1/2"	3/4"	54	25 / 1.00	50 / 0.99	75 / 0.98	100 / 0.98	100 / 0.97	100 / 0.96	100 / 0.95	100 / 0.94	100 / 0.93	100 / 0.93	100 / 0.93	100 / 0.93
	5/16"	7/8"	N/A	25 / 1.00	50 / 1.00	66 / 1.00	49 / 0.99	32 / 0.99	15 / 0.99	NR	NR	NR	NR	NR	NR
	3/8"	7/8"	108	25 / 1.00	50 / 1.00	75 / 1.00	95 / 0.99	89 / 0.99	84 / 0.99	78 / 0.98	72 / 0.98	67 / 0.98	61 / 0.97	100 / 0.97	100 / 0.97
	1/2"	7/8"	54	25 / 1.00	50 / 1.00	75 / 1.00	100 / 0.99	100 / 0.99	100 / 0.99	100 / 0.99	100 / 0.98	100 / 0.98	100 / 0.98	100 / 0.98	100 / 0.98
3.5 Ton	3/8"	3/4"	150	25 / 0.99	50 / 0.98	75 / 0.97	88 / 0.96	80 / 0.95	72 / 0.94	65 / 0.92	57 / 0.91	49 / 0.90	NR	NR	NR
	1/2"	3/4"	75	25 / 0.99	50 / 0.98	75 / 0.97	100 / 0.96	100 / 0.95	100 / 0.94	100 / 0.92	100 / 0.91	100 / 0.90	NR	NR	NR
	3/8"	7/8"	150	25 / 1.00	50 / 1.00	75 / 0.99	88 / 0.99	80 / 0.99	72 / 0.98	65 / 0.97	57 / 0.97	49 / 0.96	42 / 0.96	100 / 0.96	100 / 0.96
	1/2"	7/8"	75	25 / 1.00	50 / 1.00	75 / 0.99	100 / 0.99	100 / 0.99	100 / 0.98	100 / 0.98	100 / 0.97	100 / 0.97	100 / 0.97	100 / 0.97	100 / 0.97
	3/8"	7/8"	150	25 / 1.00	50 / 1.00	75 / 0.99	88 / 0.99	80 / 0.99	72 / 0.98	65 / 0.97	57 / 0.97	49 / 0.96	42 / 0.96	100 / 0.96	100 / 0.96
	1/2"	7/8"	75	25 / 1.00	50 / 1.00	75 / 0.99	100 / 0.99	100 / 0.99	100 / 0.98	100 / 0.98	100 / 0.97	100 / 0.97	100 / 0.97	100 / 0.97	100 / 0.97

## NOTES:

- Do not exceed 200 ft linear line length.
- Do not exceed 100 ft vertical separation if outdoor unit is above indoor unit.
- \*\*3/4" suction line should only be used for 1.5 ton systems if outdoor unit is below or at same level as indoor to assure proper oil return.
- Always use the smallest liquid line allowable to minimize refrigerant charge.
- Applications shaded in light gray indicate capacity multipliers between 0.90 and 0.96 which are not recommended, but are allowed.
- Applications shaded in dark gray are not recommended due to excessive liquid or suction pressure drop.



Air

## Refrigerant Line Size Information (con't.)

13 - 16 SEER Single-Stage Air-Conditioners													
Unit Size	Allowable Liquid Line Size	Allowable Suction Line Size	Apply Long Line Guidelines if Linear Line Length Exceeds Those Shown Below (Feet)	Equivalent Length (Feet)									
				< 25	26-50	51-75	76-100	101-125	126-150	151-175	176-200	201-225	226-250
				Maximum Vertical Rise (Outdoor Unit Below Indoor Unit) * / Capacity Multiplier									
4 Ton	3/8"	3/4"	148	25 / 0.99	50 / 0.98	75 / 0.96	77 / 0.95	67 / 0.93	57 / 0.92	46 / 0.91	NR	NR	NR
	1/2"	3/4"	74	25 / 0.99	50 / 0.98	75 / 0.96	100 / 0.95	100 / 0.93	100 / 0.92	100 / 0.91	NR	NR	NR
	3/8"	7/8"	148	25 / 1.00	50 / 0.99	75 / 0.99	77 / 0.98	67 / 0.97	57 / 0.97	46 / 0.96	36 / 0.96	26 / 0.95	15 / 0.95
	1/2"	7/8"	74	25 / 1.00	50 / 0.99	75 / 0.99	100 / 0.98	100 / 0.97	100 / 0.97	100 / 0.96	100 / 0.96	99 / 0.95	97 / 0.95
5 Ton	3/8"	3/4"	78	25 / 0.99	50 / 0.97	75 / 0.94	61 / 0.92	46 / 0.90	NR	NR	NR	NR	NR
	1/2"	3/4"	39	25 / 0.99	50 / 0.97	75 / 0.94	100 / 0.92	100 / 0.90	NR	NR	NR	NR	NR
	3/8"	7/8"	78	25 / 1.00	50 / 0.99	75 / 0.98	61 / 0.97	46 / 0.96	32 / 0.95	18 / 0.94	NR	NR	NR
	1/2"	7/8"	39	25 / 1.00	50 / 0.99	75 / 0.98	100 / 0.97	100 / 0.96	100 / 0.95	97 / 0.94	95 / 0.94	92 / 0.93	89 / 0.92
	3/8"	1-1/8"	78	25 / 1.01	50 / 1.01	75 / 1.00	61 / 1.00	46 / 0.99	32 / 0.99	18 / 0.99	NR	NR	NR
	1/2"	1-1/8"	39	25 / 1.01	50 / 1.01	75 / 1.00	100 / 1.00	100 / 0.99	100 / 0.99	97 / 0.99	95 / 0.99	92 / 0.99	89 / 0.98

## NOTES:

- 1) Do not exceed 200 ft linear line length.
- 2) \* Do not exceed 100 ft vertical separation if outdoor unit is above indoor unit.
- 3) \*\* 3/4" suction line should only be used for 1.5 ton systems if outdoor unit is below or at same level as indoor to assure proper oil return.
- 4) Always use the smallest liquid line allowable to minimize refrigerant charge.
- 5) Applications shaded in light gray indicate capacity multipliers between 0.90 and 0.96 which are not recommended, but are allowed.
- 6) Applications shaded in dark gray are not recommended due to excessive liquid or suction pressure drop.





Air

## Refrigerant Line Size Information

13 - 16 SEER Single-Stage Air-Conditioners															
Unit Size	Allowable Liquid Line Size mm [in.]	Allowable Suction Line Size mm [in.]	Apply Long Line Guidelines if Linear Line Length Exceeds Those Shown Below (Meters)	Equivalent Length (Meters)							Capacity Multiplier				
				< 8	8-15	16-23	24-30	31-38	39-46	47-53		54-61	62-69	70-76	
				Maximum Vertical Rise (Outdoor Unit Below Indoor Unit) * / Capacity Multiplier											
(-)A13 A/B				8 / 1.00	15 / 0.99	19 / 0.98	13 / 0.98	7 / 0.97	2 / 0.97	NR	NR	NR	NR	NR	NR
5.3 kW [1.5 Ton] ***SEE NOTE 3	6.35 [1/4]	15.88 [5/8]	N/A	8 / 1.00	15 / 0.99	19 / 0.98	13 / 0.98	7 / 0.97	2 / 0.97	NR	NR	NR	NR	NR	NR
	7.94 [5/16]	15.88 [5/8]	N/A	8 / 1.00	15 / 0.99	23 / 0.98	30 / 0.98	28 / 0.97	27 / 0.97	25 / 0.96	24 / 0.96	22 / 0.95	21 / 0.94	21 / 0.94	21 / 0.94
	9.53 [3/8]	15.88 [5/8]	54	8 / 1.00	15 / 0.99	23 / 0.98	30 / 0.98	30 / 0.97	30 / 0.97	30 / 0.96	30 / 0.96	30 / 0.95	30 / 0.94	30 / 0.94	30 / 0.94
	6.35 [1/4]	19.05 [3/4]**	N/A	8 / 1.00	15 / 1.00	19 / 0.99	13 / 0.99	7 / 0.99	2 / 0.99	NR	NR	NR	NR	NR	NR
	7.94 [5/16]	19.05 [3/4]**	N/A	8 / 1.00	15 / 1.00	23 / 0.99	30 / 0.99	28 / 0.99	27 / 0.99	25 / 0.99	24 / 0.98	22 / 0.98	21 / 0.98	21 / 0.98	21 / 0.98
7.0 kW [2 Ton]	9.53 [3/8]	15.88 [5/8]	54	8 / 1.00	15 / 1.00	23 / 0.99	30 / 0.99	30 / 0.99	30 / 0.99	30 / 0.99	30 / 0.98	29 / 0.97	28 / 0.97	27 / 0.96	27 / 0.96
	6.35 [1/4]	19.05 [3/4]	N/A	8 / 0.99	15 / 0.98	6 / 0.97	NR	NR	NR	NR	NR	NR	NR	NR	NR
	7.94 [5/16]	15.88 [5/8]	65	8 / 0.99	15 / 0.98	23 / 0.97	27 / 0.96	23 / 0.95	21 / 0.94	19 / 0.93	16 / 0.92	14 / 0.91	11 / 0.90	11 / 0.90	11 / 0.90
	9.53 [3/8]	15.88 [5/8]	43	8 / 0.99	15 / 0.98	23 / 0.97	30 / 0.96	30 / 0.95	30 / 0.94	30 / 0.93	29 / 0.92	28 / 0.91	27 / 0.90	27 / 0.90	27 / 0.90
	6.35 [1/4]	19.05 [3/4]	N/A	8 / 1.00	15 / 1.00	6 / 0.99	NR	NR	NR	NR	NR	NR	NR	NR	NR
8.8 kW [2.5 Ton]	7.94 [5/16]	19.05 [3/4]	65	8 / 1.00	15 / 1.00	23 / 0.99	27 / 0.99	23 / 0.98	21 / 0.98	19 / 0.98	16 / 0.97	14 / 0.97	11 / 0.96	11 / 0.96	11 / 0.96
	9.53 [3/8]	19.05 [3/4]	43	8 / 1.00	15 / 1.00	23 / 0.99	30 / 0.99	30 / 0.98	30 / 0.98	30 / 0.98	29 / 0.97	28 / 0.97	27 / 0.96	27 / 0.96	27 / 0.96
	7.94 [5/16]	15.88 [5/8]	N/A	8 / 0.99	15 / 0.98	23 / 0.96	21 / 0.94	18 / 0.93	15 / 0.91	11 / 0.90	NR	NR	NR	NR	NR
	9.53 [3/8]	15.88 [5/8]	43	8 / 0.99	15 / 0.98	23 / 0.96	30 / 0.94	30 / 0.93	29 / 0.91	27 / 0.90	NR	NR	NR	NR	NR
	7.94 [5/16]	19.05 [3/4]	65	8 / 1.00	15 / 0.99	23 / 0.99	21 / 0.98	18 / 0.98	15 / 0.97	11 / 0.96	8 / 0.96	4 / 0.95	NR	NR	NR
10.6 kW [3 Ton]	9.53 [3/8]	19.05 [3/4]	43	8 / 1.00	15 / 0.99	23 / 0.99	30 / 0.98	30 / 0.98	29 / 0.97	27 / 0.96	26 / 0.96	25 / 0.95	24 / 0.95	24 / 0.95	24 / 0.95
	7.94 [5/16]	15.88 [5/8]	N/A	8 / 0.99	15 / 0.97	20 / 0.94	15 / 0.92	10 / 0.90	NR	NR	NR	NR	NR	NR	NR
	9.53 [3/8]	15.88 [5/8]	33	8 / 0.99	15 / 0.97	23 / 0.94	29 / 0.92	27 / 0.90	NR	NR	NR	NR	NR	NR	NR
	7.94 [5/16]	19.05 [3/4]	N/A	8 / 1.00	15 / 0.99	20 / 0.98	15 / 0.98	10 / 0.97	5 / 0.96	NR	NR	NR	NR	NR	NR
	9.53 [3/8]	19.05 [3/4]	33	8 / 1.00	15 / 0.99	23 / 0.98	29 / 0.98	27 / 0.97	26 / 0.96	24 / 0.95	22 / 0.94	20 / 0.93	19 / 0.93	19 / 0.93	19 / 0.93
12.3 kW [3.5 Ton]	12.7 [1/2]	19.05 [3/4]	17	8 / 1.00	15 / 0.99	23 / 0.98	30 / 0.98	30 / 0.97	30 / 0.96	30 / 0.95	30 / 0.94	30 / 0.93	30 / 0.93	30 / 0.93	30 / 0.93
	7.94 [5/16]	22.23 [7/8]	N/A	8 / 1.00	15 / 1.00	20 / 1.00	15 / 0.99	10 / 0.99	5 / 0.99	NR	NR	NR	NR	NR	NR
	9.53 [3/8]	22.23 [7/8]	33	8 / 1.00	15 / 1.00	23 / 1.00	29 / 0.99	27 / 0.99	26 / 0.99	24 / 0.98	22 / 0.98	20 / 0.98	19 / 0.97	19 / 0.97	19 / 0.97
	1/2 [12.7]	22.23 [7/8]	17	8 / 1.00	15 / 1.00	23 / 1.00	30 / 0.99	30 / 0.99	30 / 0.99	30 / 0.99	30 / 0.98	30 / 0.98	30 / 0.98	30 / 0.97	30 / 0.97
	9.53 [3/8]	19.05 [3/4]	46	8 / 0.99	15 / 0.98	23 / 0.97	27 / 0.96	24 / 0.95	22 / 0.94	20 / 0.92	17 / 0.91	15 / 0.90	15 / 0.90	15 / 0.90	15 / 0.90
12.3 kW [3.5 Ton]	12.7 [1/2]	19.05 [3/4]	23	8 / 0.99	15 / 0.98	23 / 0.97	30 / 0.96	30 / 0.95	30 / 0.94	30 / 0.92	30 / 0.91	30 / 0.90	30 / 0.90	30 / 0.90	30 / 0.90
	9.53 [3/8]	22.23 [7/8]	46	8 / 1.00	15 / 1.00	23 / 0.99	27 / 0.99	24 / 0.99	22 / 0.98	20 / 0.97	17 / 0.97	15 / 0.96	13 / 0.96	13 / 0.96	13 / 0.96
	12.7 [1/2]	22.23 [7/8]	23	8 / 1.00	15 / 1.00	23 / 0.99	30 / 0.99	30 / 0.99	30 / 0.98	30 / 0.97	30 / 0.97	30 / 0.96	30 / 0.96	30 / 0.96	30 / 0.96

## NOTES:

- 1) Do not exceed 61 meters linear line length.
- 2) \* Do not exceed 30 meters vertical separation if outdoor unit is above indoor unit.
- 3) \* 19.05 mm [3/4 in.] vapor line should only be used for 1.5 ton systems if outdoor unit is below or at same level as indoor unit to assure proper oil return.
- 4) Always use the smallest liquid line allowable to minimize refrigerant charge.
- 5) Applications shaded in light gray indicate capacity multipliers between 0.90 and 0.96 which are not recommended, but are allowed.
- 6) Applications shaded in dark gray are not recommended due to excessive liquid or suction pressure drop.



Air

## Refrigerant Line Size Information (con't.)

13 - 16 SEER Single-Stage Air-Conditioners													
Unit Size	Allowable Liquid Line Size mm [in.]	Allowable Suction Line Size mm [in.]	Apply Long Line Guidelines if Linear Line Length Exceeds Those Shown Below (Meters)	Equivalent Length (Meters)									
				< 8	8-15	16-23	24-30	31-38	39-46	47-53	54-61	62-69	70-76
				Maximum Vertical Rise (Outdoor Unit Below Indoor Unit) * / Capacity Multiplier									
14.1 kW [4 Ton]	9.53 [3/8]	19.05 [3/4]	45	8 / 0.99	15 / 0.98	23 / 0.96	24 / 0.95	20 / 0.93	17 / 0.92	14 / 0.91	NR	NR	NR
	12.7 [1/2]	19.05 [3/4]	23	8 / 0.99	15 / 0.98	23 / 0.96	30 / 0.95	30 / 0.93	30 / 0.92	30 / 0.91	NR	NR	NR
	9.53 [3/8]	22.23 [7/8]	45	8 / 1.00	15 / 0.99	23 / 0.99	24 / 0.98	20 / 0.97	17 / 0.97	14 / 0.96	11 / 0.96	8 / 0.95	5 / 0.95
	12.7 [1/2]	22.23 [7/8]	23	8 / 1.00	15 / 0.99	23 / 0.99	30 / 0.98	30 / 0.97	30 / 0.97	30 / 0.96	30 / 0.96	30 / 0.95	30 / 0.95
17.6 kW [5 Ton]	9.53 [3/8]	19.05 [3/4]	24	8 / 0.99	15 / 0.97	23 / 0.94	19 / 0.92	14 / 0.90	NR	NR	NR	NR	NR
	12.7 [1/2]	19.05 [3/4]	12	8 / 0.99	15 / 0.97	23 / 0.94	30 / 0.92	30 / 0.90	NR	NR	NR	NR	NR
	9.53 [3/8]	22.23 [7/8]	24	8 / 1.00	15 / 0.99	23 / 0.98	19 / 0.97	14 / 0.96	10 / 0.95	5 / 0.94	NR	NR	NR
	12.7 [1/2]	22.23 [7/8]	12	8 / 1.00	15 / 0.99	23 / 0.98	30 / 0.97	30 / 0.96	30 / 0.95	30 / 0.94	29 / 0.94	28 / 0.93	27 / 0.92
	9.53 [3/8]	28.58 [1-1/8]	24	8 / 1.01	15 / 1.01	23 / 1.00	19 / 1.00	14 / 0.99	10 / 0.99	5 / 0.99	NR	NR	NR
	12.7 [1/2]	28.58 [1-1/8]	12	8 / 1.01	15 / 1.01	23 / 1.00	30 / 1.00	30 / 0.99	30 / 0.99	30 / 0.99	29 / 0.99	28 / 0.99	27 / 0.98

## NOTES:

- 1) Do not exceed 61 meters linear line length.
- 2) \*Do not exceed 30 meters vertical separation if outdoor unit is above indoor unit.
- 3) \*19.05 mm [3/4 in.] vapor line should only be used for 1.5 ton systems if outdoor unit is below or at same level as indoor unit to assure proper oil return.
- 4) Always use the smallest liquid line allowable to minimize refrigerant charge.
- 5) Applications shaded in light gray indicate capacity multipliers between 0.90 and 0.96 which are not recommended, but are allowed.
- 6) Applications shaded in dark gray are not recommended due to excessive liquid or suction pressure drop.

## Performance Data @ AHRI Standard Conditions – Cooling

Designated Tested Combination (DTC)							
Outdoor Unit	Indoor Coil	Total Capacity BTU/H [kW]	Net Sensible BTU/H [kW]	Net Latent BTU/H [kW]	SEER	EER	Indoor CFM [L/s]
RA1318	RCF2417STA	17600 [5.2]	12600 [3.7]	5000 [1.5]	13.00	11.00	600 [283.2]
RA1324	RCF2417STA	23400 [6.9]	17500 [5.1]	7000 [2.1]	13.00	11.00	800 [377.6]
RA1330	RCF3617STA	28400 [8.3]	21000 [6.2]	7400 [2.2]	13.00	11.00	1000 [471.9]
RA1336	RCF3617STA	34600 [10.1]	23400 [6.9]	11200 [3.3]	13.00	11.00	1025 [483.7]
RA1342	RCF4821STA	40500 [11.9]	28700 [8.4]	11800 [3.5]	13.00	11.00	1400 [660.7]
RA1348	RCF4821STA	47500 [13.9]	34000 [10.0]	13500 [4.0]	13.00	11.00	1500 [707.9]
RA1360	RCF6024STA	56000 [16.4]	39600 [11.6]	16400 [4.8]	13.00	11.00	1600 [755.1]

**Note:** Additional ratings and system match ups can be accessed on MyRheem.com at: <https://my.rheem.com/static/private/ahriresidential.html>  
 Additional ratings and system match ups and downloadable ratings certificates can be accessed from the AHRI website: [www.ahridirectory.org](http://www.ahridirectory.org)

[ ] Designates Metric Conversions

## GUIDE SPECIFICATIONS

### General

#### System Description

Outdoor-mounted, air-cooled, split-system air conditioner composite base pan unit suitable for ground or rooftop installation. Unit consists of a hermetic compressor, an air-cooled coil, propeller-type condenser fan, suction and legend line service valve, and a control box. Unit will discharge supply air upward as shown on contract drawings. Unit will be used in a refrigeration circuit to match up to a coil unit.

#### Quality Assurance

- Unit will be rated in accordance with the latest edition of AHRI Standard 210.
- Unit will be certified for capacity and efficiency, and listed in the latest AHRI directory.
- Unit construction will comply with latest edition of ANSI/ASHRAE and with NEC.
- Unit will be constructed in accordance with UL standards and will carry the UL label of approval. Unit will have c-UL-us approval.
- Unit cabinet will be capable of withstanding ASTM B117 1000-hr salt spray test.
- Air-cooled condenser coils will be leak tested at 150 psig and pressure tested at 550 psig.
- Unit constructed in ISO9001 approved facility.

#### Delivery, Storage, and Handling

- Unit will be shipped as single package only and is stored and handled per unit manufacturer's recommendations.

**Warranty (for inclusion by specifying engineer)** – U.S. and Canada only.

### Products

#### Equipment

Factory assembled, single piece, air-cooled air conditioner unit. Contained within the unit enclosure is all factory wiring, piping, controls, compressor, refrigerant charge R-410A, and special features required prior to field start-up.

#### Unit Cabinet

- Unit cabinet will be constructed of galvanized steel, bonderized, and coated with a powder coat paint.
- All units constructed with louver coil protection and corner post. Louver can be removed by removing one fastener per louver panel.

### AIR-COOLED, SPLIT-SYSTEM AIR CONDITIONER

#### RA13

#### 1-1/2 TO 5 NOMINAL TONS

#### Fans

- Condenser fan will be direct-drive propeller type, discharging air upward.
- Condenser fan motors will be totally enclosed, 1-phase type with class B insulation and permanently lubricated bearings. Shafts will be corrosion resistant.
- Fan blades will be statically and dynamically balanced.
- Condenser fan openings will be equipped with coated steel wire safety guards.

#### Compressor

- Compressor will be hermetically sealed.
- Compressor will be mounted on rubber vibration isolators.

#### Condenser Coil

- Condenser coil will be air cooled.
- Coil will be constructed of aluminum fins mechanically bonded to copper tubes.

#### Refrigeration Components

- Refrigeration circuit components will include liquid-line shutoff valve with sweat connections, vapor-line shutoff valve with sweat connections, system charge of R-410A refrigerant, and compressor oil.
- Unit will be equipped with filter drier for R-410A refrigerant for field installation.

#### Operating Characteristics

- The capacity of the unit will meet or exceed \_\_\_\_\_ Btuh at a suction temperature of \_\_\_\_\_ °F/°C. The power consumption at full load will not exceed \_\_\_\_\_ kW.
- Combination of the unit and the evaporator or fan coil unit will have a total net cooling capacity of \_\_\_\_\_ Btuh or greater at conditions of \_\_\_\_\_ CFM entering air temperature at the evaporator at \_\_\_\_\_ °F/°C wet bulb and \_\_\_\_\_ °F/°C dry bulb, and air entering the unit at \_\_\_\_\_ °F/°C.
- The system will have a SEER of \_\_\_\_\_ Btuh/watt or greater at DOE conditions.

#### Electrical Requirements

- Nominal unit electrical characteristics will be \_\_\_\_\_ v, single phase, 60 hz. The unit will be capable of satisfactory operation within voltage limits of \_\_\_\_\_ v to \_\_\_\_\_ v.
- Nominal unit electrical characteristics will be \_\_\_\_\_ v, three phase, 60 hz. The unit will be capable of satisfactory operation within voltage limits of \_\_\_\_\_ v to \_\_\_\_\_ v.
- Unit electrical power will be single point connection.
- Control circuit will be 24v.

#### Special Features

- Refer to section of this literature identifying accessories and descriptions for specific features and available enhancements.

**GENERAL TERMS OF LIMITED WARRANTY\***

Rheem will furnish a replacement for any part of this product which fails in normal use and service within the applicable period stated, in accordance with the terms of the limited warranty.

**\*For complete details of the Limited and Conditional Warranties, including applicable terms and conditions, contact your local contractor or the Manufacturer for a copy of the product warranty certificate.**

Conditional Parts  
(Registration Required) .....Ten (10) Years